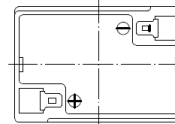
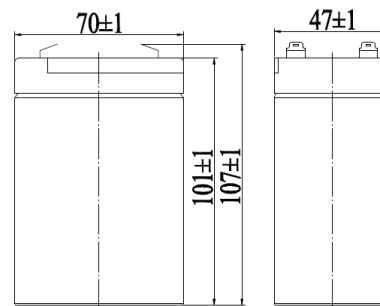
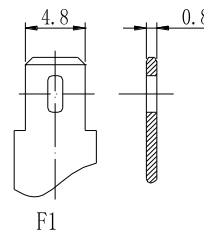

Specifications

Nominal Voltage		6 V
Capacity (25°C)	20HR(5.25V)	4.5Ah
	10HR(5.25V)	4.2Ah
	1HR(4.80V)	2.95Ah
Dimension	Length	70 ± 1mm (2.76inch)
	Width	47 ± 1mm (1.85inch)
	Height	101 ± 1mm (3.98inch)
	Total Height	107 ± 1mm (4.21inch)
Approx. Weight		0.74kg (1.63lbs) ± 5%
Terminal type		F1
Internal resistance (Fully charged, 25°C)		Approx. 25mΩ
Capacity affected by temperature (20HR)	40°C	102%
	25°C	100%
	0°C	85%
	-15°C	65%
Self-discharge (25°C)	3 month	Remaining Capacity: 91%
	6 month	Remaining Capacity: 82%
	12 month	Remaining Capacity: 65%
Nominal operating temperature		25°C ± 3°C (77°F ± 5°F)
Operating temperature range	Discharge	-15°C ~ 50°C (5°F ~ 122°F)
	Charge	-10°C ~ 50°C (14°F ~ 122°F)
	Storage	-20°C ~ 50°C (-4°F ~ 122°F)
Float charging voltage(25°C)		6.80 to 6.90V Temperature compensation: -9mV/°C
Cyclic charging voltage(25°C)		7.25 to 7.50V Temperature compensation: -15mV/°C
Maximum charging current		1.35A
Maximum discharge current		67.5A(5 sec.)
Designed floating life(20°C)		5 years

Dimensions

Terminal

Constant Current Discharge Characteristics (A, 25°C)

F.V/TIME	5min	10min	15min	30min	60min	2h	3h	4h	5h	10h	20h
4.80V	17.2	10.9	8.51	4.79	2.95	1.61	1.12	0.92	0.78	0.43	0.228
4.95V	16.7	10.6	8.30	4.70	2.90	1.60	1.11	0.92	0.78	0.42	0.227
5.10V	16.0	10.13	7.99	4.55	2.83	1.59	1.10	0.91	0.77	0.42	0.226
5.25V	15.3	9.69	7.72	4.44	2.77	1.56	1.09	0.90	0.77	0.42	0.225
5.40V	14.4	9.15	7.31	4.28	2.69	1.52	1.06	0.88	0.75	0.41	0.221

Constant Power Discharge Characteristics (Watt, 25°C)

F.V/TIME	5min	10min	15min	30min	60min	2h	3h	4h	5h	10h	20h
4.80V	95.9	61.4	48.5	27.46	17.07	9.43	6.63	5.49	4.69	2.56	1.37
4.95V	93.0	59.6	47.3	26.91	16.81	9.38	6.59	5.46	4.66	2.55	1.36
5.10V	89.2	57.1	45.6	26.09	16.38	9.29	6.54	5.42	4.63	2.53	1.36
5.25V	85.4	54.7	44.0	25.46	16.06	9.15	6.50	5.39	4.59	2.52	1.35
5.40V	80.6	51.6	41.7	24.52	15.56	8.92	6.30	5.22	4.46	2.47	1.32

Note: The above characteristics data can be obtained within three charge/discharge cycles.

Construction

Component	Positive plate	Negative plate	Container	Cover	Separator	Electrolyte	Safety valve	Terminal
Raw material	Lead dioxide	Lead	ABS	ABS	AGM	Sulfuric acid	Rubber	Copper

Discharge Characteristics(25°C)

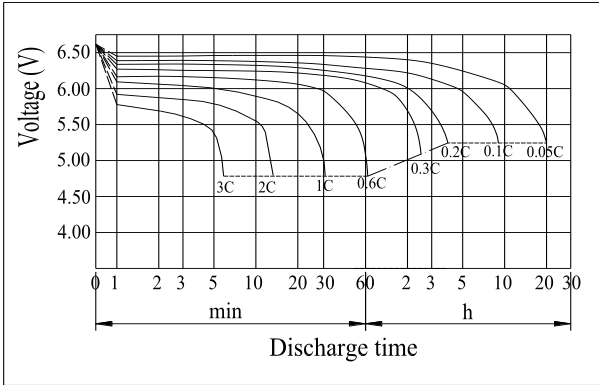

The Relationship for Open Circuit Voltage and Residual Capacity (25°C)

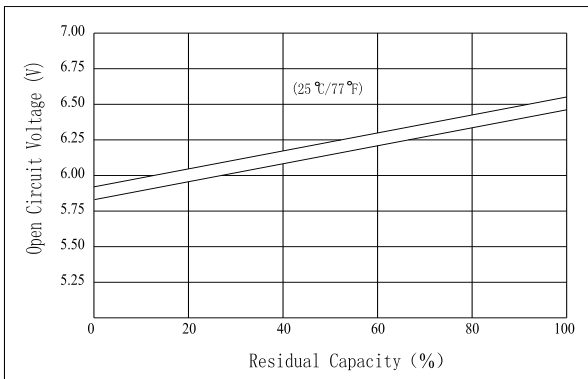

Floating Life on Temperature

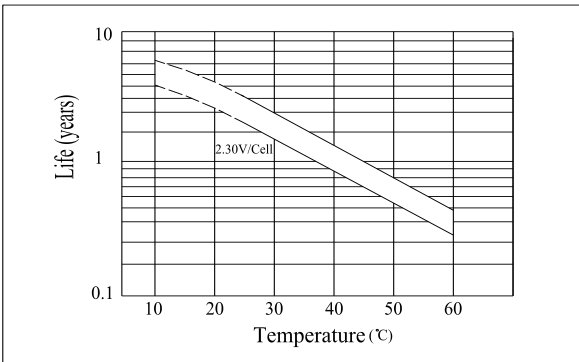

Effect of Temperature on Capacity

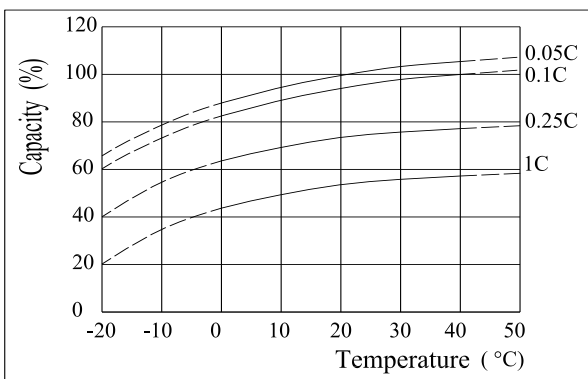

Charging Characteristics(25°C)

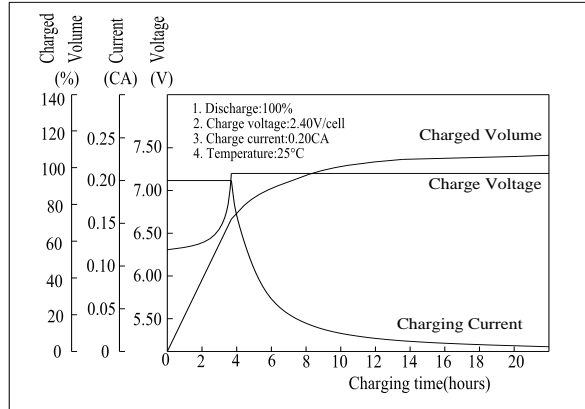

The Relationship for Charging Voltage and Temperature

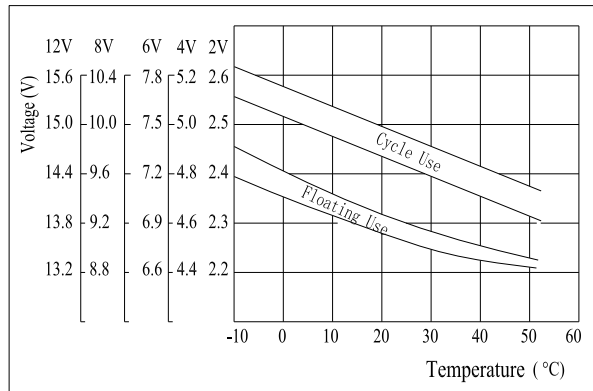

Cycle Life on D.O.D(25°C)

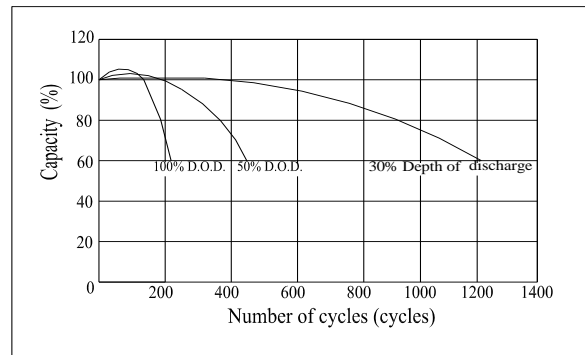

Self-discharge Characteristics

