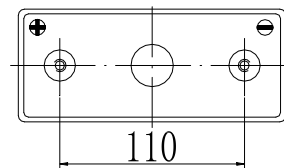
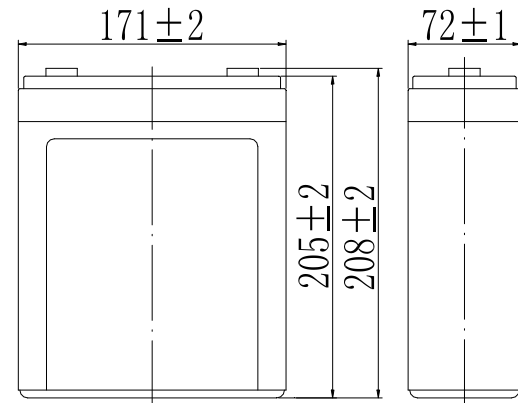
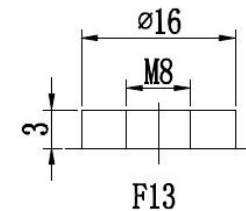

Specifications

Nominal Voltage		2 V
Capacity (25°C)	10HR(1.80V)	100 Ah
	3HR(1.75V)	75Ah
	1HR(1.75V)	56Ah
Dimension	Length	171 ± 2mm (6.73inch)
	Width	72 ± 1mm (2.83inch)
	Height	205 ± 2mm (8.07inch)
	Total Height	208 ± 2mm (8.19inch)
Approx. Weight		5.6kg (12.3lbs) ± 5%
Terminal type		F13
Internal resistance (Fully charged, 25°C)		Approx. 0.8m Ω
Capacity affected by temperature (10HR)	40°C	102%
	25°C	100%
	0°C	85%
	-15°C	65%
Self-discharge (25°C)	3 month	Remaining Capacity: 91%
	6 month	Remaining Capacity: 82%
	12 month	Remaining Capacity: 65%
Nominal operating temperature		25°C ± 3°C (77°F ± 5°F)
Operating temperature range	Discharge	-15°C ~ 50°C (5°F ~ 122°F)
	Charge	-10°C ~ 50°C (14°F ~ 122°F)
	Storage	-20°C ~ 50°C (-4°F ~ 122°F)
Float charging voltage(25°C)		2.25 to 2.30V Temperature compensation: -3mV/°C
Cyclic charging voltage(25°C)		2.42 to 2.50V Temperature compensation: -5mV/°C
Maximum charging current		20A
Maximum discharge current		800A(5 sec.)
Designed floating life(20°C)		12 years

Dimensions

Terminal

Constant Current Discharge Characteristics (A, 25°C)

F.V/TIME	10min	15min	30min	60min	2h	3h	4h	5h	8h	10h	20h
1.60V	211	163	97.5	59.9	36.5	26.0	21.0	18.0	12.3	10.2	5.40
1.65V	205	159	95.5	59.0	36.3	25.9	20.9	17.8	12.3	10.2	5.38
1.70V	197	153	92.6	57.5	36.0	25.7	20.7	17.7	12.2	10.1	5.37
1.75V	188	148	90.4	56.3	35.5	25.5	20.6	17.6	12.1	10.1	5.34
1.80V	178	140	87.1	54.6	34.6	24.7	20.0	17.1	11.7	10.0	5.30

Constant Power Discharge Characteristics (Watt, 25°C)

F.V/TIME	10min	15min	30min	60min	2h	3h	4h	5h	8h	10h	20h
1.60V	381	298	182	114	70.5	51.0	41.2	35.4	24.4	20.3	10.8
1.65V	369	291	179	112	70.1	50.7	40.9	35.2	24.3	20.2	10.8
1.70V	354	280	173	109	69.5	50.3	40.7	34.9	24.1	20.2	10.7
1.75V	339	271	169	107	68.4	50.0	40.4	34.7	24.0	20.0	10.7
1.80V	320	256	163	104	66.7	48.5	39.2	33.6	23.2	19.9	10.6

Note: The above characteristics data can be obtained within three charge/discharge cycles.

Construction

Component	Positive plate	Negative plate	Container	Cover	Separator	Electrolyte	Safety valve	Terminal
Raw material	Lead dioxide	Lead	ABS	ABS	AGM	Sulfuric acid	Rubber	Copper

Discharge Characteristics(25°C)

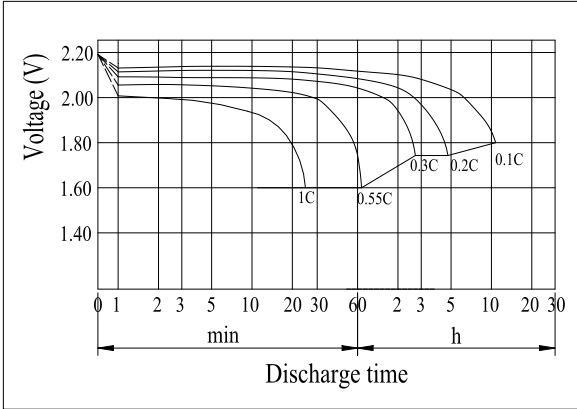

The Relationship for Open Circuit Voltage and Residual Capacity (25°C)

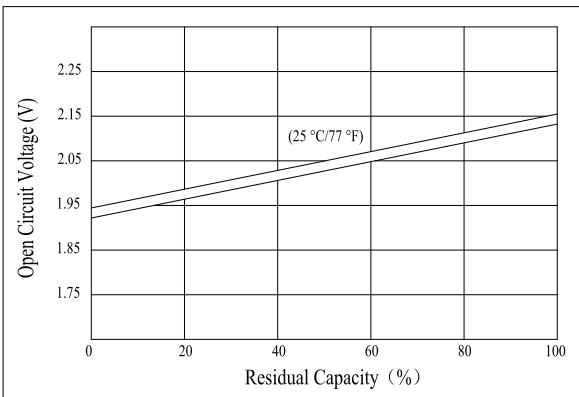

Floating Life on Temperature

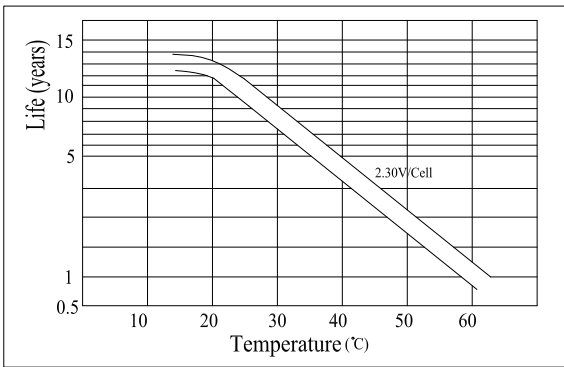

Effect of Temperature on Capacity

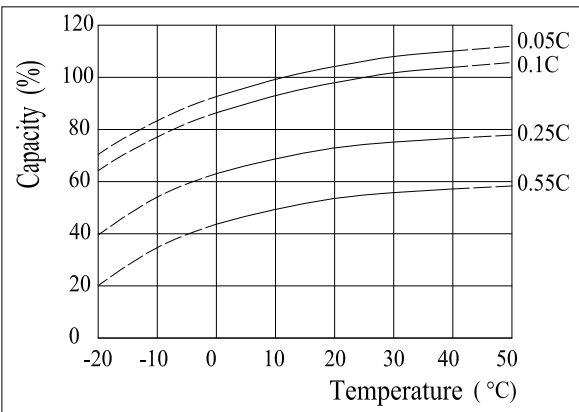

Charging Characteristics(25°C)

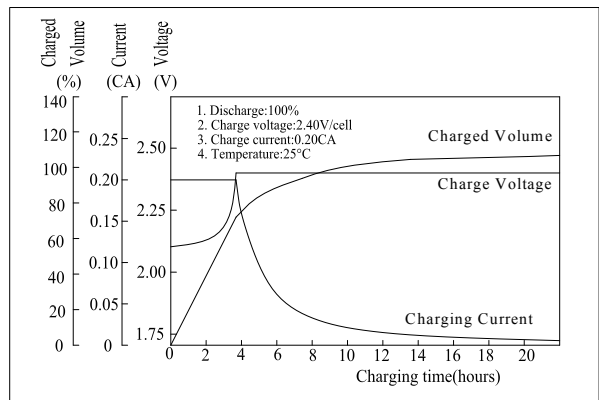

The Relationship for Charging Voltage and Temperature

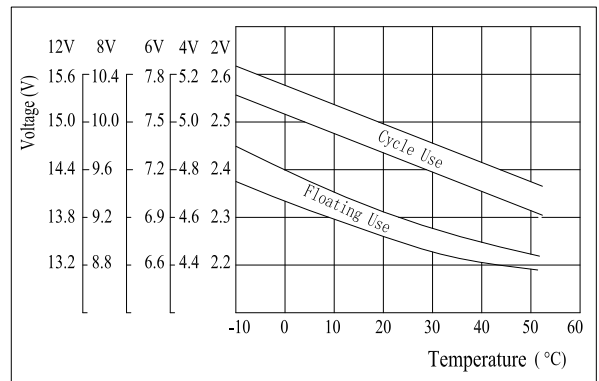

Cycle Life on D.O.D(25°C)

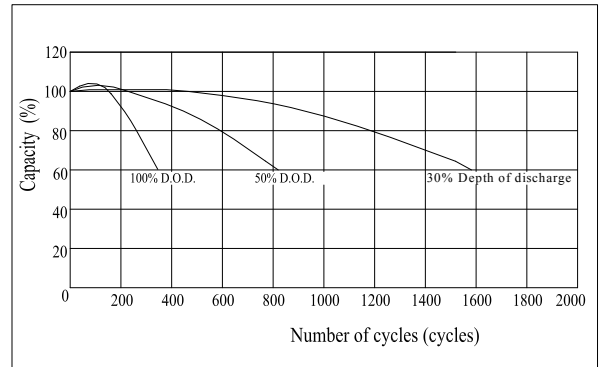

Self-discharge Characteristics

