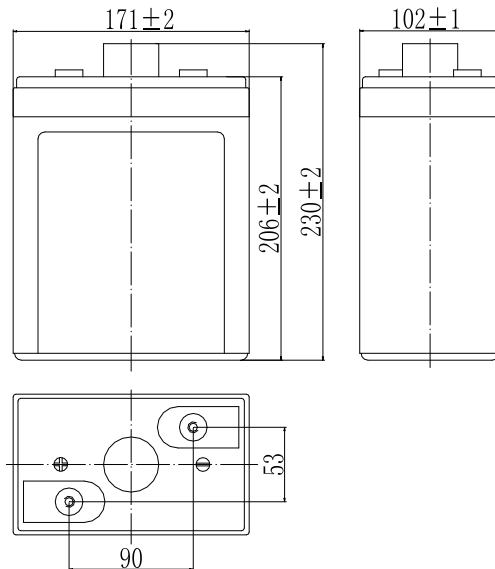
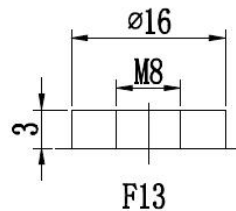

Specifications

Nominal Voltage		2 V
Capacity (25°C)	10HR(1.80V)	150 Ah
	3HR(1.75V)	114Ah
	1HR(1.75V)	84Ah
Dimension	Length	171 ± 2mm (6.73inch)
	Width	102 ± 1mm (4.02inch)
	Height	206 ± 2mm (8.11inch)
	Total Height	230 ± 2mm (9.06inch)
Approx. Weight		8kg (17.6lbs) ± 5%
Terminal type		F13
Internal resistance (Fully charged, 25°C)		Approx. 0.6m Ω
Capacity affected by temperature (10HR)	40°C	102%
	25°C	100%
	0°C	85%
	-15°C	65%
Self-discharge (25°C)	3 month	Remaining Capacity: 91%
	6 month	Remaining Capacity: 82%
	12 month	Remaining Capacity: 65%
Nominal operating temperature		25°C ± 3°C (77°F ± 5°F)
Operating temperature range	Discharge	-15°C ~ 50°C (5°F ~ 122°F)
	Charge	-10°C ~ 50°C (14°F ~ 122°F)
	Storage	-20°C ~ 50°C (-4°F ~ 122°F)
Float charging voltage(25°C)		2.25 to 2.30V Temperature compensation: -3mV/°C
Cyclic charging voltage(25°C)		2.42 to 2.50V Temperature compensation: -5mV/°C
Maximum charging current		30A
Maximum discharge current		1200A(5 sec.)
Designed floating life(20°C)		12 years

Dimensions

Terminal

Constant Current Discharge Characteristics (A, 25°C)

F.V/TIME	10min	15min	30min	60min	2h	3h	4h	5h	8h	10h	20h
1.60V	317	244	146	89.9	54.8	39.0	31.5	26.9	18.5	15.3	8.09
1.65V	308	239	143	88.6	54.5	38.8	31.3	26.8	18.4	15.2	8.08
1.70V	295	230	139	86.3	54.0	38.5	31.1	26.6	18.3	15.2	8.05
1.75V	282	222	136	84.5	53.2	38.3	30.9	26.4	18.2	15.1	8.01
1.80V	266	210	131	81.9	51.8	37.1	30.0	25.6	17.6	15.0	7.95

Constant Power Discharge Characteristics (Watt, 25°C)

F.V/TIME	10min	15min	30min	60min	2h	3h	4h	5h	8h	10h	20h
1.60V	571	447	273	171	106	76.5	61.8	53.0	36.7	30.4	16.2
1.65V	554	437	268	168	105	76.0	61.4	52.7	36.4	30.3	16.2
1.70V	531	420	260	164	104	75.5	61.0	52.4	36.2	30.2	16.1
1.75V	508	406	253	161	103	75.0	60.6	52.0	35.9	30.1	16.0
1.80V	480	385	244	156	100	72.7	58.7	50.4	34.9	29.9	15.9

Note: The above characteristics data can be obtained within three charge/discharge cycles.

Construction

Component	Positive plate	Negative plate	Container	Cover	Separator	Electrolyte	Safety valve	Terminal
Raw material	Lead dioxide	Lead	ABS	ABS	AGM	Sulfuric acid	Rubber	Copper

Discharge Characteristics(25°C)

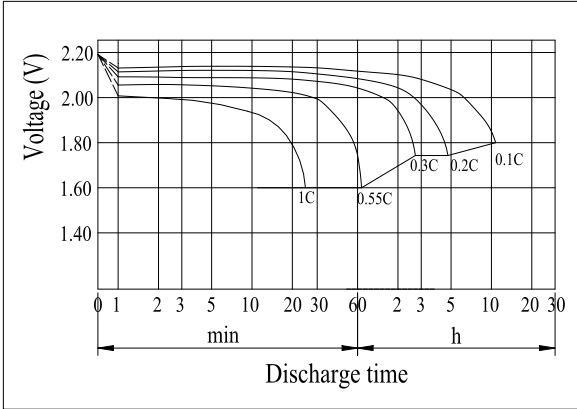

The Relationship for Open Circuit Voltage and Residual Capacity (25°C)

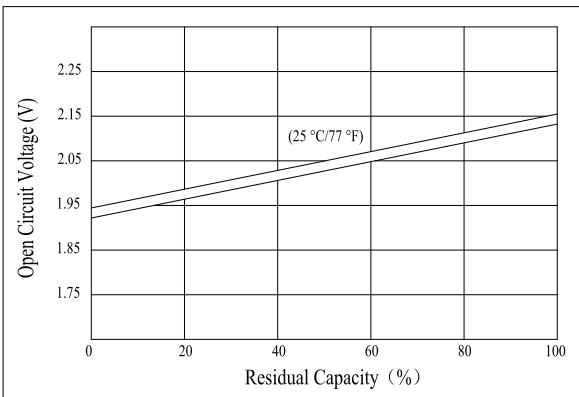

Floating Life on Temperature

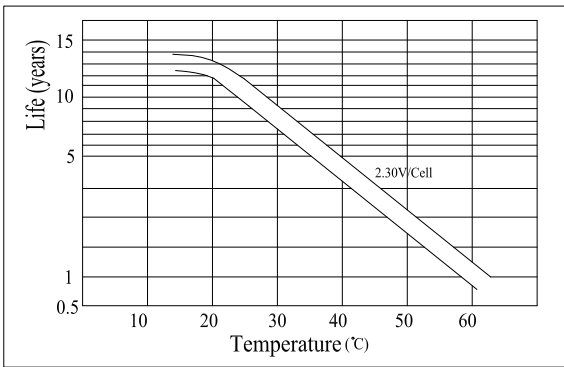

Effect of Temperature on Capacity

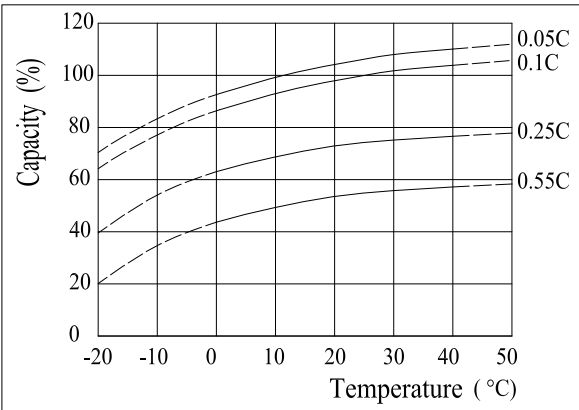

Charging Characteristics(25°C)

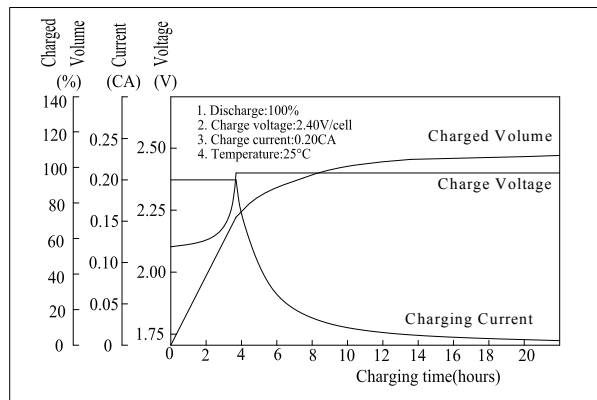

The Relationship for Charging Voltage and Temperature

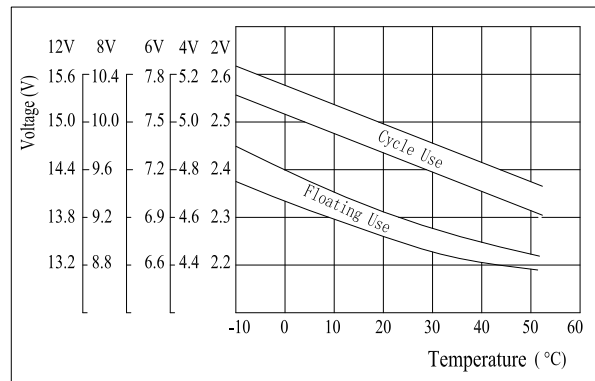

Cycle Life on D.O.D(25°C)

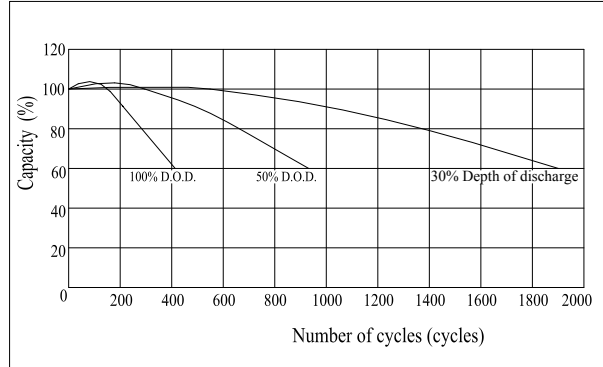

Self-discharge Characteristics

