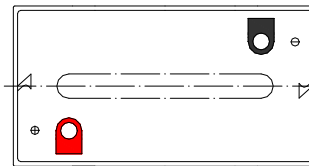
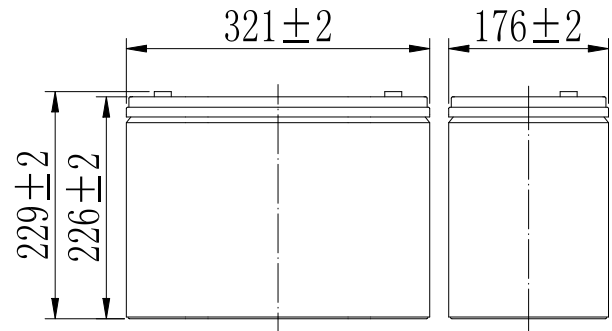
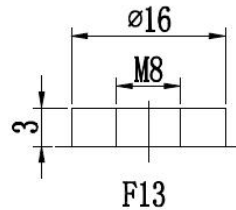

Specifications

Nominal Voltage		6 V
Capacity (25°C)	10HR(5.40V)	200 Ah
	5HR(5.25V)	176Ah
	1HR(4.80V)	124Ah
Dimension	Length	321 ± 2mm (12.64inch)
	Width	176 ± 2mm (6.93inch)
	Height	226 ± 2mm (8.90inch)
	Total Height	229 ± 2mm (9.02inch)
Approx. Weight		29.5kg (65lbs) ± 4%
Terminal type		F13
Internal resistance (Fully charged, 25°C)		Approx. 2m Ω
Capacity affected by temperature (10HR)	40°C	102%
	25°C	100%
	0°C	85%
	-15°C	65%
Self-discharge (25°C)	3 month	Remaining Capacity: 91%
	6 month	Remaining Capacity: 82%
	12 month	Remaining Capacity: 65%
Nominal operating temperature		25°C ± 3°C (77°F ± 5°F)
Operating temperature range	Discharge	-15°C ~ 50°C (5°F ~ 122°F)
	Charge	-10°C ~ 50°C (14°F ~ 122°F)
	Storage	-20°C ~ 50°C (-4°F ~ 122°F)
Float charging voltage(25°C)		6.75 to 6.90V Temperature compensation: -9mV/°C
Cyclic charging voltage(25°C)		7.25 to 7.50V Temperature compensation: -15mV/°C
Maximum charging current		60A
Maximum discharge current		1600A(5 sec.)
Designed floating life(20°C)		10 years

Dimensions

Terminal

Constant Current Discharge Characteristics (A, 25°C)

F.V/TIME	10min	15min	30min	60min	2h	3h	4h	5h	8h	10h	20h
4.80V	436	336	201	124	73.1	52.0	42.0	35.9	24.7	20.4	10.8
4.95V	423	328	197	122	72.6	51.7	41.8	35.7	24.5	20.3	10.8
5.10V	405	316	191	119	72.0	51.4	41.5	35.4	24.4	20.3	10.7
5.25V	388	305	186	116	70.9	51.0	41.2	35.2	24.2	20.1	10.7
5.40V	366	289	179	113	69.1	49.5	40.0	34.1	23.5	20.0	10.6

Constant Power Discharge Characteristics (Watt, 25°C)

F.V/TIME	10min	15min	30min	60min	2h	3h	4h	5h	8h	10h	20h
4.80V	2354	1845	1128	705	423	306	247	212	147	122	64.7
4.95V	2284	1800	1105	694	421	304	246	211	146	121	64.6
5.10V	2190	1734	1071	676	417	302	244	209	145	121	64.4
5.25V	2095	1675	1045	662	411	300	242	208	144	120	64.0
5.40V	1978	1586	1007	642	400	291	235	202	139	119	63.6

Note: The above characteristics data can be obtained within three charge/discharge cycles.

Construction

Component	Positive plate	Negative plate	Container	Cover	Separator	Electrolyte	Safety valve	Terminal
Raw material	Lead dioxide	Lead	ABS	ABS	AGM	Sulfuric acid	Rubber	Copper

Discharge Characteristics(25°C)

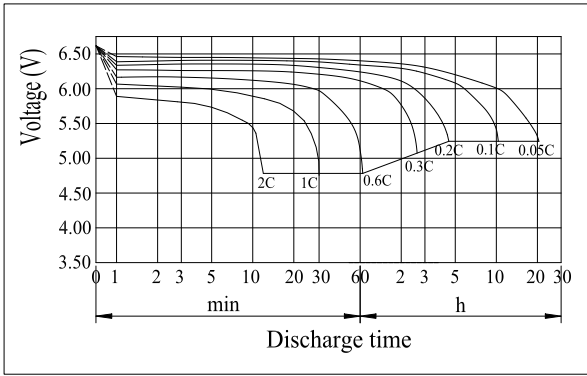

Charging Characteristics(25°C)

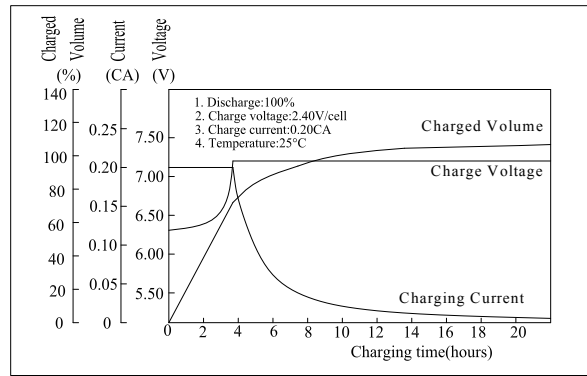

The Relationship for Open Circuit Voltage and Residual Capacity (25°C)

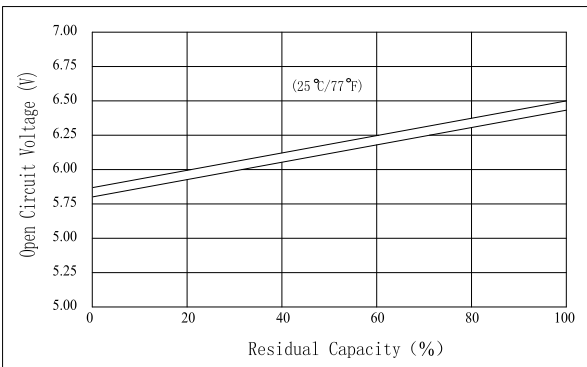

The Relationship for Charging Voltage and Temperature

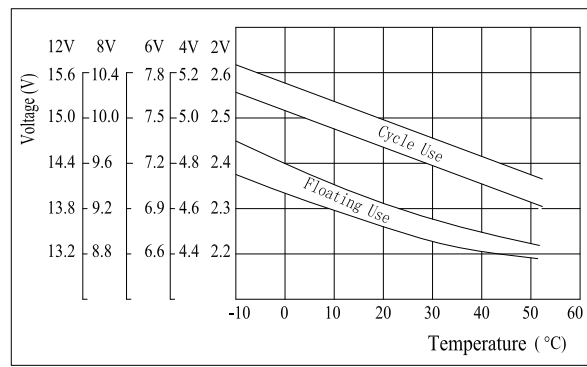

Floating Life on Temperature

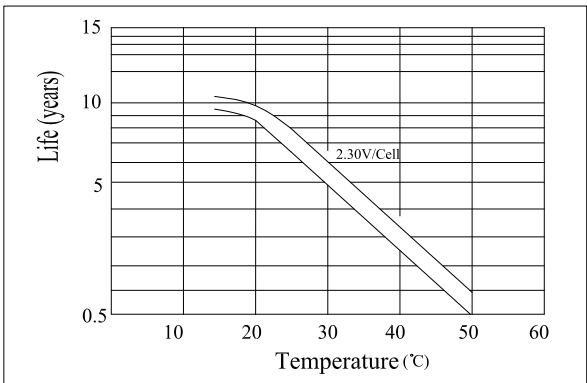

Cycle Life on D.O.D(25°C)

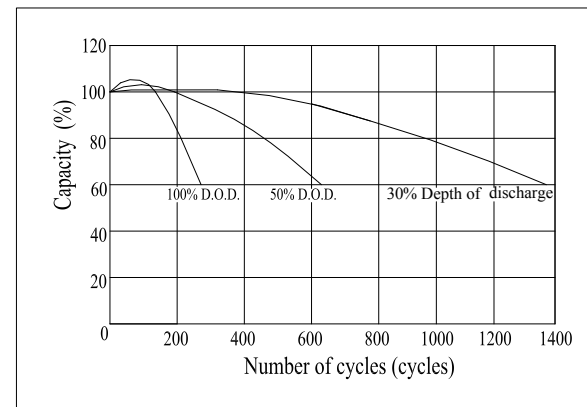

Effect of Temperature on Capacity

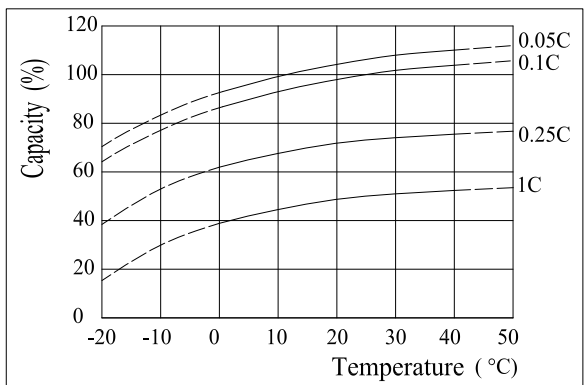

Self-discharge Characteristics

